

IN2112, IN2114, IN2116

# IN2100 (SERIES)



Regulatory models: V2000, M2100

**InFocus**  
Bright Ideas Made Brilliant

010-0735-00

**InFocus**

## Declaration of Conformity

Manufacturer: InFocus Corporation, 27500 SW Parkway Ave. Wilsonville, Oregon 97070 USA

We declare under our sole responsibility that this projector conforms to the following directives and norms:

EMC Directive 2004/108/EC

EuP Directive 2005/32/EC

EMC: EN 55022

EN 55024

EN 61000-3-2

EN 61000-3-3

Low Voltage Directive 2006/95/EC

Safety: IEC 60950-1:2005, MOD

## Trademarks

Apple, Macintosh, and PowerBook are trademarks or registered trademarks of Apple Computer, Inc. IBM is a trademark or registered trademark of International Business Machines, Inc. Microsoft, PowerPoint, and Windows are trademarks or registered trademarks of Microsoft Corporation. Adobe and Acrobat are trademarks or registered trademarks of Adobe Systems Incorporated. DLP® and the DLP logo are registered trademarks of Texas Instruments and BrilliantColor™ is a trademark of Texas Instruments. InFocus, In Focus, and INFOCUS (stylized) are either registered trademarks or trademarks of InFocus Corporation in the United States and other countries.

## FCC Warning

This device complies with part 15 of the FCC Rules. Operation is subject to the following two conditions: (1) This device may not cause harmful interference, and (2) this device must accept any interference received, including interference that may cause undesired operation.

**NOTE:** This equipment has been tested and found to comply with the limits for a Class B digital device, pursuant to part 15 of the FCC Rules. These limits are designed to provide reasonable protection against harmful interference in a residential installation. This equipment generates, uses and can

radiate radio frequency energy and, if not installed and used in accordance with the instructions, may cause harmful interference to radio communications. However, there is no guarantee that interference will not occur in a particular installation. If this equipment does cause harmful interference to radio or television reception, which can be determined by turning the equipment off and on, the user is encouraged to try to correct the interference by one or more of the following measures:

--Reorient or relocate the receiving antenna.

--Increase the separation between the equipment and receiver.

--Connect the equipment into an outlet on a circuit different from that to which the receiver is connected.

--Consult the dealer or an experienced radio/TV technician for help.

Changes or modifications to this equipment that are not expressly approved by InFocus Corp. may void the user's authority to operate the equipment.

## Canada

This Class B digital apparatus complies with Canadian ICES-003.

Cet appareil numérique de la classe B est conforme à la norme NMB-003 du Canada.

## Agency Approvals

cMETus

Other specific Country Approvals may apply. Please see product certification label.

This document applies to regulatory model V2000 and M2100.

Input ratings: AC 100-240V, 2.5A, 50-60Hz

InFocus reserves the right to alter product offerings and specifications at any time without notice.

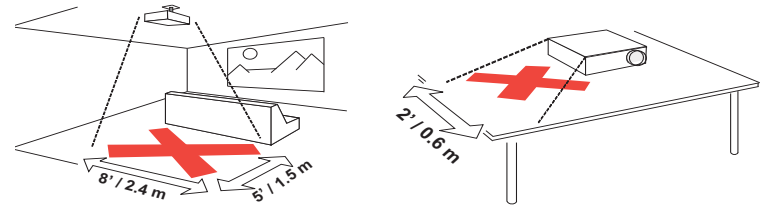
## Table of Contents

Introduction	4
Positioning the projector	6
Ceiling Mount	7
Connecting power	8
Connecting a computer source	8
Optional computer connections	9
Displaying an image	10
Adjusting the image	11
Connecting a video device	12
Video device connections	12
Shutting down the projector	14
Troubleshooting your setup	14
Using the remote control	22
Using the audio	23
Using the keypad buttons	24
Optimizing computer images	24
Presentation features	24
Optimizing video images	25
Customizing the projector	25
Dynamic Messaging	25
Using the menus	26
Basic Picture menu	27
Advanced Picture menu	28
Setup menu	29
Status and Service menu	32
Help	32
Using Network Functions (IN2114 & IN2116 only)	33
Using LitePort (IN2114 & IN2116 only)	37
Maintenance	40
Cleaning the lens	40
Replacing the projection lamp	41
Using the security lock	42
INDEX	43

## Important Operating Considerations for Safety

- Refer to this guide for proper startup and shutdown procedures.
- Follow all warnings and cautions in this manual and on the projector.
- Place the projector in a horizontal position no greater than 8 degrees off axis.
- Locate the projector at least 4' (1.2m) away from any heating or cooling vents.
- Do not block ventilation openings. Locate the projector in a well-ventilated area without obstructions to intake or exhaust vents. Do not place the projector on a tablecloth or other soft covering that may block the vents.
- Do not place the projector in direct sunlight, humid, greasy or dusty places or in places where the projector may come into contact with smoke or steam.
- Do not look directly into the lens while the projector is being used.
- Do not drop the projector.
- Do not spill liquid on the projector. Spilled liquid may damage the projector.
- Use the power cord provided. Connect the power cord to a receptacle with a protective safety (earth) ground terminal. A surge-protected power strip is recommended.
- Do not overload wall outlets.
- When disconnecting the power cord, hold the plug, not the cord.
- Wash hands after handling the cables supplied with this product.
- The projector remote control uses batteries. Make sure the batteries' polarity (+/-) is aligned correctly. Dispose of used batteries in accordance with local disposal laws.
- Use an InFocus approved ceiling mount kit for proper fitting, ventilation and installation. The warranty does not cover any damage caused by use of non-approved ceiling mount kits or by installing in an improper location.

- When the projector is ceiling mounted, wear protective eyewear to prevent eye injury before opening lamp door.
- Refer all service to qualified service personnel. Servicing your own projector can be dangerous to you and will void the warranty.
- Only use replacement parts specified by InFocus. Unauthorized substitutions may result in fire, electrical shock, or injury, and may void the warranty.
- Only genuine InFocus lamps are tested for use in this projector. Use of non InFocus lamps may cause electrical shock and fire, and may void the projector warranty.
- Hg – Lamp contains mercury. Manage in accordance with local disposal laws. See [www.lamprecycle.org](http://www.lamprecycle.org).
- The projector uses a high-pressure mercury glass lamp. The lamp may fail prematurely, or it may rupture with a popping sound if jolted, scratched, or handled while hot. The risk of lamp failure or rupture also increases as the lamp age increases; please replace the lamp when you see the "Replace Lamp" message.
- In the unlikely event of a lamp rupture, particles may exit through the projector vents. Keep people, food, and drinks out of the "keep out" area under and around the projector, as indicated by the "X" areas below.



Follow these instructions to help ensure image quality and lamp life over the life of the projector. Failure to follow these instructions may affect the warranty. For complete details of the warranty, see the Warranty Booklet.

# Introduction

Your new digital projector is simple to connect, easy to use, and straightforward to maintain. It is a versatile projector that is flexible enough for business presentations and home video viewing, too. The IN2112 has native SVGA 800 x 600 resolution, the IN2114 has native XGA 1024x768 resolution, and the IN2116 has WXGA 1280x800 resolution. This guide applies to both products. They are compatible with a wide variety of computers and video devices.

## Product specifications

To read the latest specifications on your multimedia projector, be sure to visit our support website at [www.infocus.com/support](http://www.infocus.com/support), as specifications are subject to change.

## Online registration

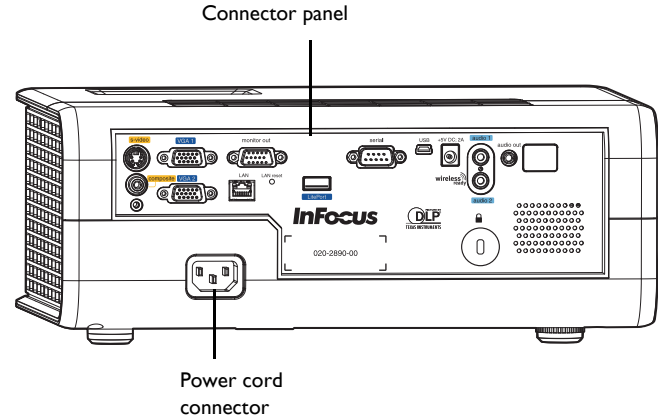
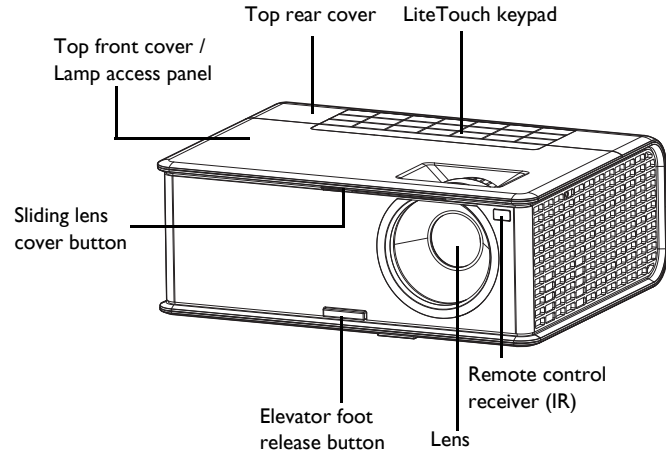
Register your projector on our website at [www.infocus.com/register](http://www.infocus.com/register) to activate your warranty and receive product updates, announcements, and registration incentives.

## Included Items

The standard accessories which came with your projector are listed in the included Quick Start poster.

## Optional Accessories

Optional accessories include the Commander-2 remote, ceiling mount, and LiteShow II. These items and other accessories can be found on our website at [www.infocus.com](http://www.infocus.com) or at your local dealer.



## Connector panel

The projector provides both computer and video connection options, including:

- VGA computer (2)
- S-video
- Composite video
- Separate audio inputs for video and computer

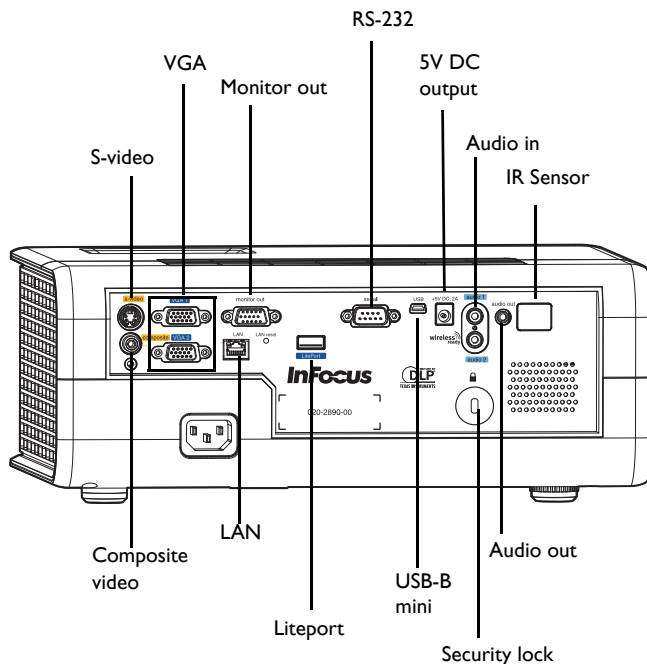
The projector also provides the following connectors:

- Monitor out, to provide an image on your desktop computer as well as on the projection screen.
- Audio out, to provide sound for external speakers.
- 5 volt DC output
- RS-232 connector for serial control. Command control codes are available on our support website at [www.infocus.com/support](http://www.infocus.com/support).
- USB-B mini for firmware upgrades and presentation control.
- **IN2114 & IN2116 only:** LitePort, for connecting a USB flash drive containing JPEG images.
- **IN2114 & IN2116 only:** LAN port for network control and web server.

**NOTE:** Only VGA video is sent to the **Monitor out** connector.

## 5 volt DC output

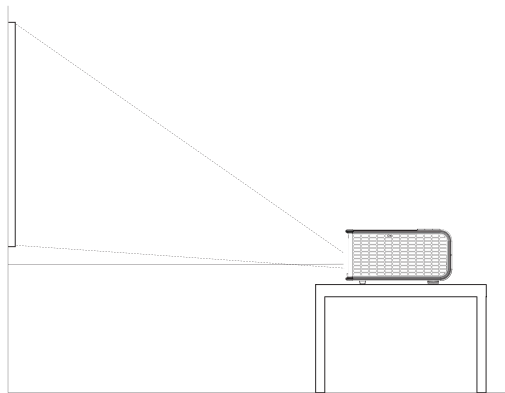
The coaxial 6.4mm x 2.2mm jack provides a constant 5 volt, 2 amp DC output when the projector is on, and will also provide power when the projector is powered off, if Network item in the Always-On Functions submenu is set to Yes. It is designed to provide power to an InFocus LiteShow II wireless device.



## Positioning the projector

To determine where to position the projector, consider the size and shape of your screen, the location of your power outlets, and the distance between the projector and the rest of your equipment. Here are some general guidelines:

- Position the projector on a flat surface at a right angle to the screen. The projector must be at least 4.9' (1.5m) from the projection screen.
- Position the projector within 10' (3m) of your power source and within 6' (1.8m) of your video device (unless you purchase extension cables). To ensure adequate cable access, do not place the projector within 6" (.15m) of a wall or other object.
- Position the projector to the desired distance from the screen. The distance from the lens of the projector to the screen, the zoom setting, and the video format determine the size of the projected image.
- The image exits the projector at a given angle. This image offset is 115%. This means that for an image 10' high, the bottom of the image will be 1.15' above the center of the lens.



**Table 1: IN2112 (SVGA) and IN2114 (XGA)**  
*Range of distance to the screen for a given screen size*

Diagonal Screen Size (inches/m)	Distance to screen	
	Minimum distance (feet/m)	Maximum Distance (feet/m)
60"/1.52m	6.48'/1.98m	7.80'/2.38m
80"/2.03m	8.64'/2.63m	10.40'/3.17m
90"/2.29m	9.72'/2.96m	11.70'/3.57m
150"/3.81m	16.20'/4.94m	19.50'/5.94m

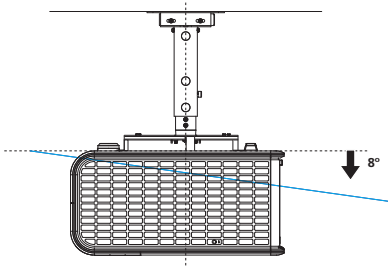
**Table 2: IN2116 (WXGA)**  
*Range of distance to the screen for a given screen size*

Diagonal Screen Size (inches/m)	Distance to screen	
	Minimum distance (feet/m)	Maximum Distance (feet/m)
60"/1.52m	6.21'/1.89m	7.74'/2.36m
80"/2.03m	8.34'/2.54m	10.36'/3.16m
90"/2.29m	9.40'/2.86m	11.68'/3.56m
150"/3.81m	15.77'/4.81m	19.55'/5.96m

## Ceiling Mount

If you wish to install the projector on the ceiling:

- We strongly recommend using InFocus approved ceiling mounts for proper fitting, ventilation and installation. Refer to the installation guide that comes with the InFocus Ceiling Mount Kit (p/n SP-CEIL-UNIV) for more information. The warranty does not cover any damage caused by use of non-approved ceiling mount kits or by installing in an improper location.
- The ceiling must be strong enough to support the projector and the installation must be in accordance with any local building codes. Consult your dealer for more information.
- Maximum supported physical pitch is  $\pm 8^\circ$ .
- Maximum supported physical horizontal roll is  $\pm 8^\circ$ .
- Keep all adjacent surfaces 3" (76mm) from sides, front and rear and .87" (22mm) from the bottom of projector to preserve required airflow around the projector.



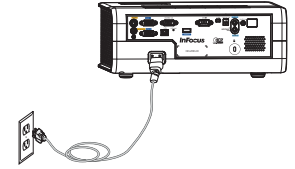


## Connecting power

Connect the black power cord to the **Power** connector on the rear of the projector and to your electrical outlet. The Power light on the Status Indicator Panel (page 14) turns amber.

**NOTE:** Always use the power cord that shipped with the projector.

Connect power cord

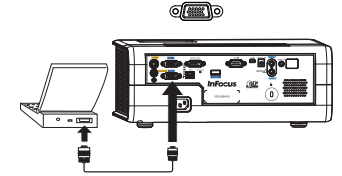


## Connecting a computer source

### VGA connection

Connect one end of the provided computer cable to the **VGA 1** or **VGA 2** connector on the projector and the other to the VGA connector on your computer. If you are using a desktop computer, you will need to disconnect the monitor cable from the computer's video port first (you can connect this monitor cable to the **Monitor Out** connector on the projector, see next page).

Connect computer cable



## Optional computer connections

To get sound from the projector, connect an audio cable (optional cable, not included) to your computer and to the **Audio 1** or **Audio 2** connector on the projector. (Default settings are as follows: Audio 1 is used with VGA 1 and VGA 2; Audio 2 is used with S-video and composite.) You can also assign a your source to a different audio in connector, see page 23 and page 30. You may also need an adapter.

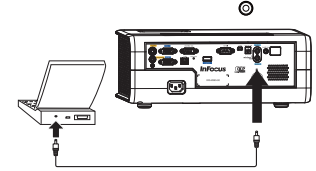
If you are using a desktop computer and want to see the image on your computer screen as well as on the projection screen, connect the computer's monitor cable to the **Monitor Out** connector on the projector.

**NOTE:** Only VGA video is sent to the **Monitor out** connector.

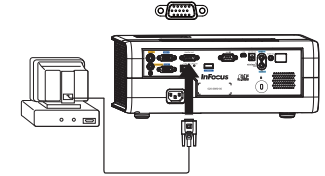
To advance slides in a PowerPoint presentation using the remote control, plug a USB cable between the projector's **USB** connector and your computer. Then press the up and down arrow buttons on the remote control to move through your slides.

**IN2114 & IN2116 only:** To display a presentation from a USB flash drive, see the Using LitePort section on page 37. This feature eliminates the need for a computer source and can be integrated with common wall plates and conference room input/output panels.

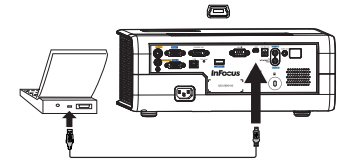
Connect audio cable



Connect monitor cable



Connect USB cable



## Displaying an image

Touch the **Power** button on the keypad or the remote.

The Power button blinks green and the fans start to run. When the lamp turns on, the start up screen will display and the Power button will become solid green. It can take a minute for the image to achieve full brightness.

**No start up screen?** Get help on page 15.

Slide the lens cover to the side, if it is covering the lens.

Turn on your computer or video device.

The image should appear on the projection screen. If it doesn't, press the **Source** button on the projector's keypad or remote.

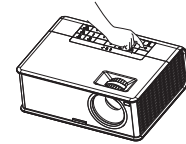
**If you are using a VGA cable to connect your computer to the projector:**

If using a laptop, make sure its external video port is active.

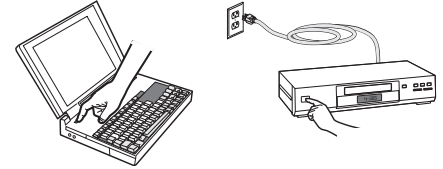
Many laptops do not automatically turn on their external video port when a projector is connected. Usually a key combination like Fn + F8 or CRT/LCD key turns the external display on and off. Locate a function key labeled CRT/LCD or a function key with a monitor symbol. Press Fn and the labeled function key simultaneously. Refer to your laptop's documentation for more information about your laptop's key combination or go to the InFocus website at: <http://www.infocus.com/Support/LaptopActivation.aspx>.

**No laptop image?** Try pressing the **Auto Image** button on the keypad.

Press Power button



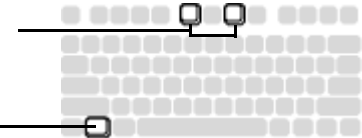
Turn on computer or video device



Activate laptop's external port



Monitor key or  
LCD/CRT key



## Adjusting the image

If necessary, adjust the height of the projector by pressing the elevator foot release button to extend the foot.

Rotate the elevator feet for granular adjustment of the projector's height. Avoid placing your hands near the hot exhaust vent at the side of the projector.

Avoid placing your hands near the hot exhaust vent at the side of the projector.

Position the projector to the desired distance from the screen at a 90 degree angle to the screen. See page 6 for a table listing to screen sizes and distances.

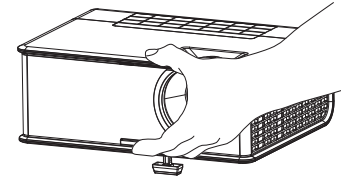
Adjust the zoom or focus.

If the image is not square, first make sure that the projector is perpendicular to the screen. To reduce the size of the top edge of the image, press the top Keystone button. To reduce the size of the bottom edge of the image, press the bottom Keystone button.

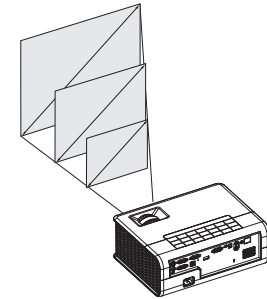
If the left or right side of the screen is larger or smaller than the other, you can turn the projector to the left or to the right a few degrees to square the image. See page 6 for details.

Adjust the Contrast or Brightness in the Basic Picture menu. See page 27 for help with these menu adjustments.

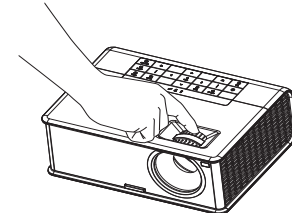
Adjust height



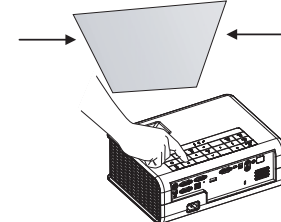
Adjust distance



Adjust zoom and focus



Adjust keystone



## Connecting a video device

You can connect video devices such as VCRs, DVD players, camcorders, digital cameras, video game consoles, HDTV receivers, and TV tuners to the projector. You can connect the audio directly to the projector to get sound from the built-in speaker, or you can bypass the projector's audio system and connect the audio directly from your source to a stereo or home theater system.

You can connect the projector to most video devices that can output video. You cannot directly connect the coaxial cable that enters your house from a cable or satellite company; the signal must pass through a tuner first. Examples of tuners are digital cable boxes, VCRs, digital video recorders, and satellite TV boxes. Basically, any device that can change channels is considered a tuner.

Although the aspect ratio is automatically selected by the projector based on the signal input, you can change the aspect ratio, if desired. The projector's Aspect Ratio setting is accessed through the Resize button on the remote or through the projector's Basic Picture Menu. See page 27 for more information.

## Video device connections

No video cables are provided with the projector. You can order cables from InFocus or use your own.

### Composite video connection

Plug the composite video cable's yellow connector into the video out connector on the video device. Plug the other yellow connector into the yellow **Composite** connector on the projector.

Plug the white connector of a Mini-plug audio Y-cable into the left audio out connector on the video device and plug the red connector into the right audio out connector on the video device. Plug the other end of the cable into the associated audio in connector on the projector.

Keep in mind that video output from composite connections is not as high quality as S-video.

### S-video connection

If your video device uses a round, four-prong S-video connector, plug an S-video cable into the S-video connector on your video device and into the **S-video** connector on the projector. Use the audio cable as described above.

Keep in mind that video output from S-video connections is not as high quality as component.

### VGA connection

If your video device has a 15-pin VGA output, plug one end of the included computer cable into the VGA connector on your video source. This connector may be labeled "To Monitor" on the video source. Plug the computer cable into the **VGA 1** or **VGA 2** connector on the projector.

### Component video connection

A Component to VGA adapter can be used in conjunction with the VGA connectors. Plug the component cable into the video device. Plug the other end of the component cable into the adapter and plug the adapter into the **VGA 1** or **VGA 2** connector.

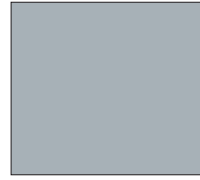
Component offers the highest quality video output.

## What is Aspect Ratio?

Aspect ratio is the ratio of the image width to image height. Standard TV screens and older laptops are 4:3; HDTV and most DVDs are 16:9; and widescreen computers are 16:10. If you are projecting onto a screen, the size/shape of the screen will influence the aspect ratio you decide to use. If you are projecting onto a blank wall, there are no screen size restrictions. What you plan to project will also help you choose between 4:3, 16:9 or 16:10. Many TV shows are 4:3, while most movies are 16:9.

If you have a 16:9 screen then you should select an aspect ratio of 16:9 for widescreen movies or HDTV, and Native for 4:3 content. If you have a 4:3 screen you should still use 16:9 for widescreen movies or HDTV, but you also have the option of using either 4:3 (to fill the screen) or Native (for direct pixel mapping) for 4:3 content. Force Wide can also be enabled to automatically resize less common aspect ratios to 16:10.

4:3 screen



16:9 screen



4:3 mode



16:9 mode



Native mode

# Shutting down the projector

## Screen Save Time

You can make the black screen appear after a preset number of minutes by turning on the Screen Save Time feature in the Setup menu. See page 29.

## Auto Off Time

The projector has an Auto Off Time feature that automatically turns the projector off if no active sources are detected and no user interaction with the projector is performed for 30 minutes. By default, this feature is off. You can change the length of time, see page 29.

## Turning off the projector





To turn the projector off, press the **Power** button on the remote or keypad. The lamp turns off and the LED blinks amber for 10 seconds while the fans continue to run to cool the lamp. When the lamp has cooled, the LED lights amber and the fans stop. Unplug the power cable to completely power off the projector.

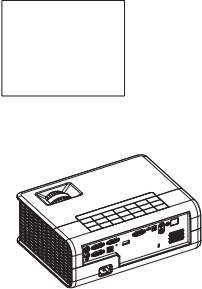
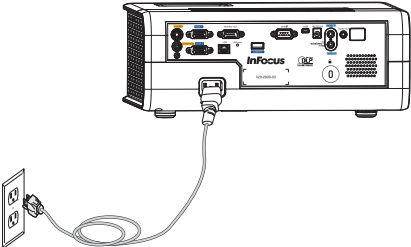
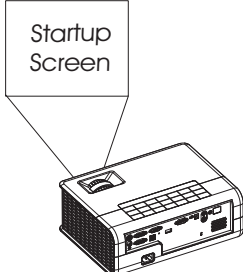
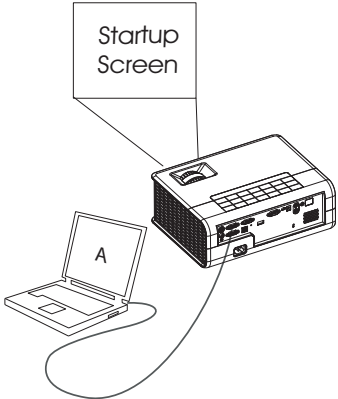

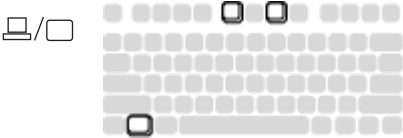

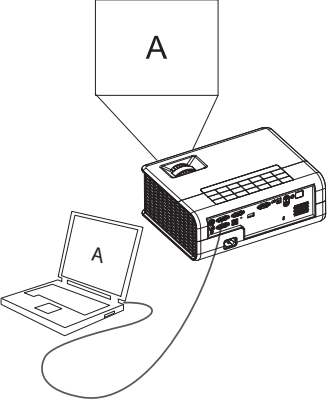
# Troubleshooting your setup

The Status Indicator Panel on top of the projector indicates the state of the projector and is a helpful when troubleshooting.

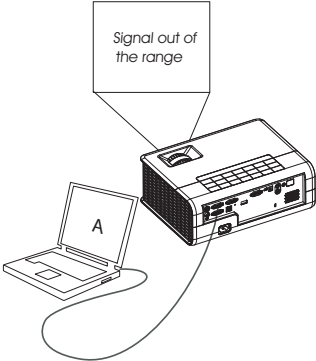
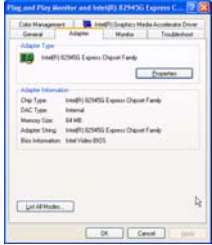
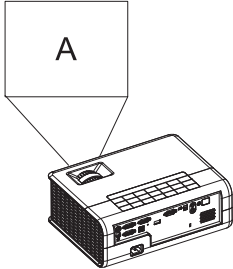
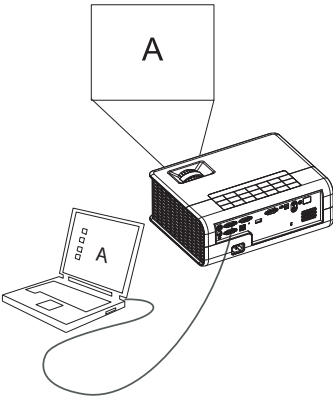

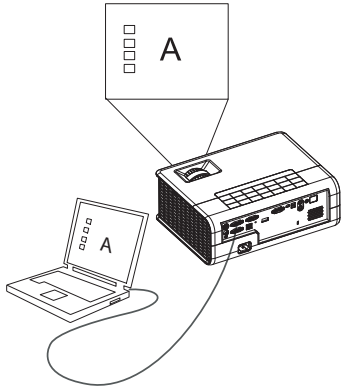


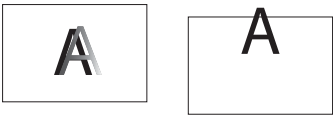


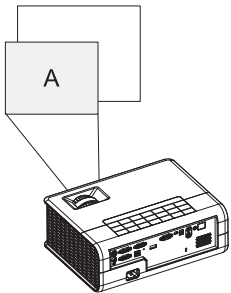
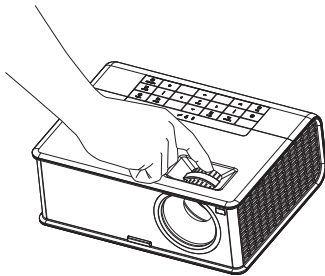
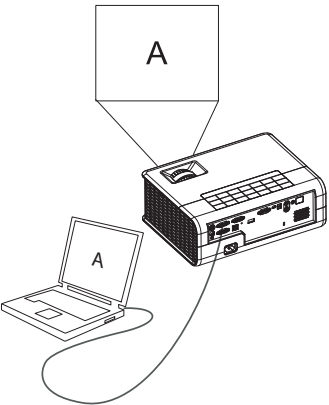
**Table 3: Status indicator light behavior and meaning**

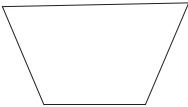





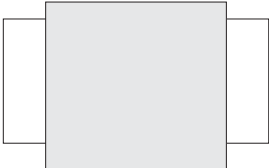

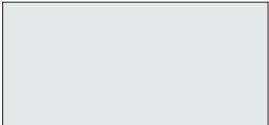
Icon	Meaning
Power, solid amber 	The projector is plugged in.
Power, blinking green	The power button has been pressed and the software is initializing.
Power, solid green	The projector is on and initialized.
Power, blinking amber	The power button has been pressed to turn the projector off and the fans are running to cool the projector.
Temperature 	The projector is too hot. Make sure the vents aren't blocked (see page 20). Turn the projector off and wait one minute, then turn the projector on again. Contact Technical Support if the problem persists. Visit <a href="http://www.infocus.com/support">www.infocus.com/support</a> to contact service.
Lamp 	Turn the projector off and wait one minute, then turn the projector on again. If the lamp light turns on again, replace the lamp and reset the lamp timer (page 42).
Wrench/Service 	Turn the projector off and wait one minute, then turn the projector on again. If the service lamp turns on again, service is required. Visit <a href="http://www.infocus.com/support">www.infocus.com/support</a> to contact service.


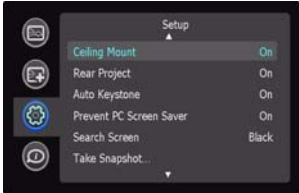







Problem	Solution	Result
<p data-bbox="48 127 244 152">No start up screen</p> 	<p data-bbox="661 127 1065 181">Plug power cord into the projector then press power button</p> 	<p data-bbox="1183 127 1334 152">Correct image</p> 
<p data-bbox="48 500 340 525">Only start up screen appears</p> 	<p data-bbox="661 512 986 557">Press the Source button  Activate the laptop's external port</p>  <p data-bbox="673 839 808 864">Restart laptop</p> 	<p data-bbox="1183 500 1456 525">Computer image projected</p> 

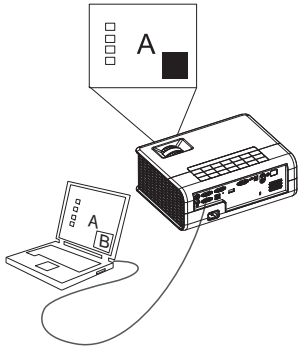
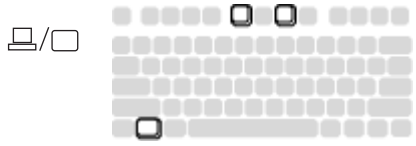
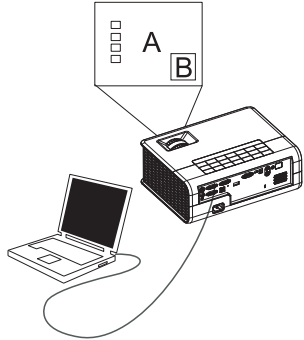
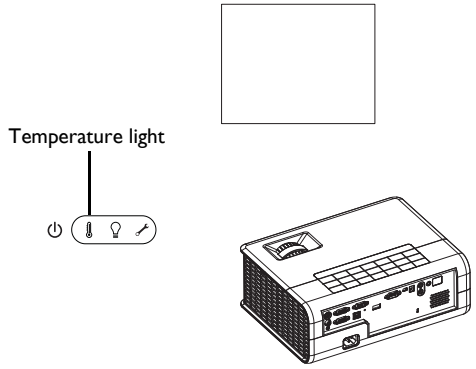
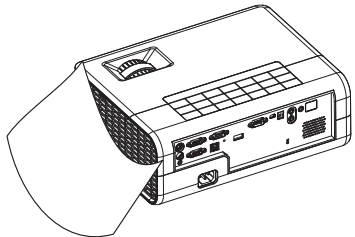
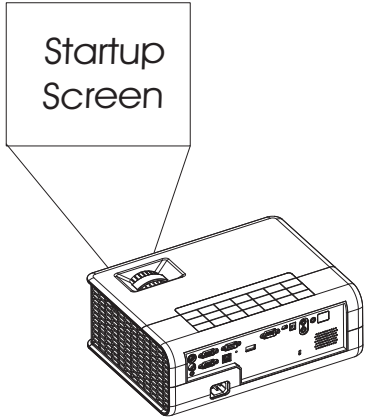


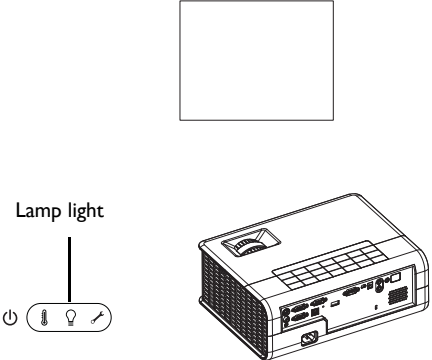
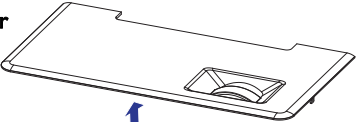
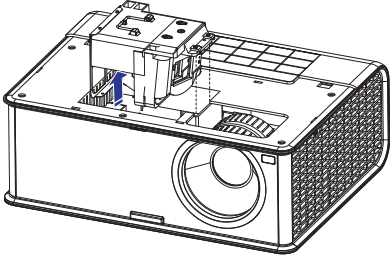
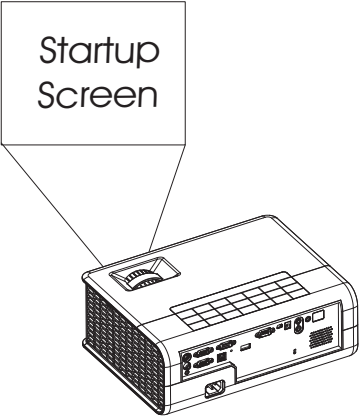
Problem	Solution	Result
<p data-bbox="48 135 541 189"><b>No computer image, just the words “Signal out of range”</b></p> 	<p data-bbox="604 135 1152 230"><b>Press the Auto Image button on the keypad or remote. To adjust computer refresh rate, go to Control Panel &gt; Display &gt; Settings &gt; Advanced &gt; Adapter (location varies by operating system).</b></p>  <p data-bbox="604 498 1152 569"><b>You may also need to set a different resolution on your computer, as shown in the following problem, “image fuzzy or cropped”</b></p>	<p data-bbox="1183 135 1451 161"><b>Computer image projected</b></p> 
<p data-bbox="48 586 506 640"><b>Only my laptop’s background appears, not the Desktop icons</b></p> 	<p data-bbox="604 586 1152 657"><b>Windows - Disable “Extend my Windows Desktop” in Control Panel &gt; Display &gt; Settings &gt; Display 2 (location varies by operating system)</b></p>  <p data-bbox="614 953 739 1036"><b>Uncheck this option, then click Apply</b></p>	<p data-bbox="1183 586 1534 613"><b>Background and Desktop projected</b></p> 

Problem	Solution	Result
<p data-bbox="48 89 286 114">Image fuzzy or cropped</p> 	<p data-bbox="604 89 1145 172">Set your computer's display resolution to the native resolution of the projector (Start &gt; Settings &gt; Control Panel &gt; Display &gt; Settings tab)</p> <p data-bbox="656 309 815 441">For a laptop, disable laptop monitor or turn-on dual-display mode</p> 	<p data-bbox="1180 89 1466 114">Image clear and not cropped</p> 
<p data-bbox="48 539 347 562">Image not centered on screen</p> 	<p data-bbox="604 539 928 562">Move projector and adjust zoom</p> 	<p data-bbox="1180 539 1328 562">Correct image</p> 

Problem	Solution	Result
<p data-bbox="48 89 222 114">Image not square</p> 	<p data-bbox="604 89 1020 114">Adjust Keystone in the Basic Picture menu</p> 	<p data-bbox="1180 89 1315 114">Square image</p> 
<p data-bbox="48 338 210 363">Image not sharp</p> 	<p data-bbox="604 338 1025 363">Adjust Sharpness in the Basic Picture menu</p> 	<p data-bbox="1180 338 1326 363">Correct image</p> 
<p data-bbox="48 614 413 639">Image does not fit 4:3 or 16:9 screen</p> 	<p data-bbox="604 614 1020 669">Change aspect ratio to 4:3 or 16:9 in Basic Picture&gt;Aspect Ratio menu</p> 	<p data-bbox="1180 614 1326 639">Correct image</p> 

Problem	Solution	Result
<p>Image upside down</p> 	<p>Turn off Ceiling Mount in Setup menu</p> 	<p>Correct image</p> 
<p>Image reversed left to right</p> 	<p>Turn off Rear Project in Setup menu</p> 	<p>Correct image</p> 
<p>Projected colors don't match source</p> 	<p>Adjust color, tint, brightness, contrast in the Basic Picture menu and/or color space in the Advanced Picture menu</p> 	<p>Correct image</p> 

Problem	Solution	Result
<p>The video embedded in my PowerPoint presentation does not play on the screen</p> 	<p>Turn off the internal LCD display on your laptop</p> 	<p>Embedded video plays correctly</p> 
<p>Lamp won't turn on, Temperature light is on</p> 	<p>Make sure vents aren't blocked, turn the projector off and allow it to cool for one minute.</p> 	<p>Lamp turns on</p> 

Problem	Solution	Result
<p data-bbox="48 92 531 146">“Replace lamp” message appears at startup, lamp won’t turn on, Lamp light is turned on</p> 	<p data-bbox="604 92 970 121">Lamp must be replaced (see page 41)</p> <p data-bbox="604 144 769 169">Top front cover</p>  <p data-bbox="604 282 739 307">Replace lamp</p> 	<p data-bbox="1180 92 1328 118">Lamp turns on</p> 

### Still need assistance?

If you need assistance, visit our support website at [www.infocus.com/support](http://www.infocus.com/support) or call us. Check out the How To section for additional information on using this projector for home theater or gaming applications.

This product is backed by a limited warranty. An extended warranty plan may be purchased from your dealer. When sending the projector in for repair, we recommend shipping the unit in its original packing material, or having a professional packaging company pack the unit. Please insure your shipment for its full value.

# Using the remote control

The remote uses two (2) provided AA batteries. You can install the batteries by removing the cover from the remote's back, aligning the + and - ends of the batteries, sliding them into place, and then replacing the cover.

## Caution:

- When replacing the batteries, be aware that using batteries other than the type provided with the projector may risk severe damage to the remote. When disposing of the batteries, be sure to do so in an environmentally proper manner.
- If the remote control gets wet, wipe it dry immediately.
- Avoid excessive heat and humidity.
- Ensure the batteries' polarity (+/-) is aligned correctly.
- Do not mix new and old batteries together, or different types of batteries together.
- Replace the batteries as soon as they run out.
- Remove batteries from the remote control when storing or not in use for a prolonged period.

To operate, point the remote at the projector (not at the computer). The range of optimum operation is about 30' (9m).

Press the remote's **Power** button to turn the projector on and off (see page 14 for shutdown information).

Press the remote's **Menu** button to open the projector's menu system. Use the arrow buttons to navigate, and the **Select** button to select features and adjust values in the menus. See page 26 for more information on the menus.

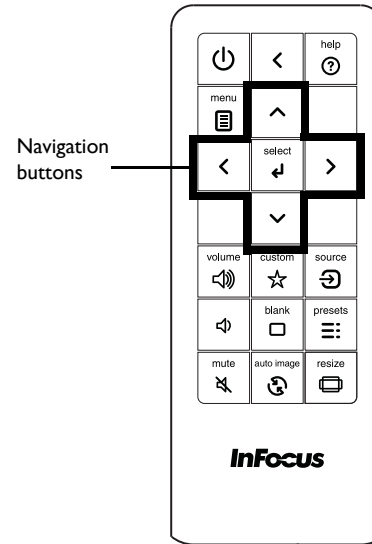
The remote also has:

- **Help** button to access the projector's help feature (see page 32).
- **Volume** buttons to adjust the sound.
- **Custom** button that can be assigned to a special function, like Blank Screen or Freeze (see page 29).
- **Source** button to switch between sources.
- **Blank** button to blank the screen.

- **Presets** button to select stored settings (see page 27).
- **Mute** button to silence the audio.
- **Auto Image** button to resynchronize the projector to the source.
- **Resize** button to switch among aspect ratios (see page 27).

## Troubleshooting the remote

- Make sure the batteries are installed in the proper orientation and are not dead.
- Make sure you're pointing the remote at the projector or the screen, not the computer, and are within the remote range of 30' (9m). For best results, point the remote at the projector.



# Using the audio

## Using the projector's speakers

To use the projector's speaker, connect your source to the Audio In Computer or Video connectors.

To adjust the volume, press the **Volume** buttons on the keypad or remote.

## Troubleshooting Audio

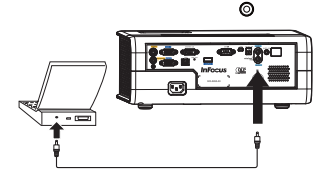
If you aren't hearing the audio, check the following:

- Make sure the audio cable is connected to the correct audio in connector, Computer or Video.
- Make sure the volume is turned up enough. Press the **Volume** button on the keypad or remote.
- Make sure you are connected to the corresponding audio in for your source.
- Make sure that you are connected to an audio out connector on the source as opposed to a line in or microphone connector.
- Adjust the audio source.
- If playing a video, make sure the playback has not been paused.

## Connecting external speakers

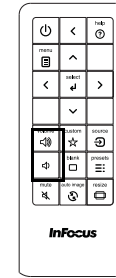
The projector can be attached to external amplified speakers by connecting a 3.5mm stereo audio cable from the **Audio Out** connector on the projector to the amplified speakers. Alternatively, you can bypass the projector's audio system and connect the audio directly from your source to a stereo or home theater system.

### Connect audio cable

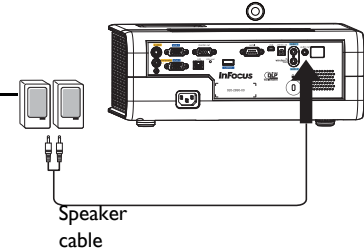


### Adjust volume

volume



External speakers with own power source





## Using the keypad buttons

Most buttons are described in detail in other sections, but here is an overview of their functions:

**Power**—turns the projector on and off (page 8).

**Auto Image**—resynchronize the projector to the source.

**Presets**—cycles through the available preset settings (page 27).

**Menu**—opens the onscreen menus (page 26).

**Select**—confirms choices made in the menus (page 26).

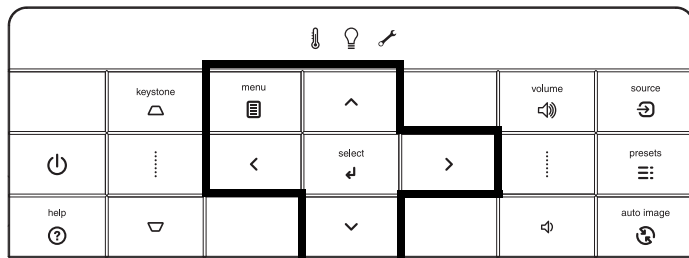
**Up/Down/Left/Right arrows**—navigates to and adjusts settings in the menus (page 26).

**Volume**—adjusts sound (page 23).

**Source**—changes the active source (page 8).

**Help**—button to access the projector’s help feature (page 32)

**Keystone**—adjusts squareness of the image (page 11).



Menu navigation  
buttons

## Optimizing computer images

After the projector is running and the image is on the screen, you can optimize the image using the onscreen menus. For general information on using the menus, see page 26.

- Adjust the Keystone, Contrast, or Brightness in the Basic Picture menu (page 27).
- Change the Aspect Ratio. Choose the option that best fits your input source (page 27).
- Adjust the Color Temperature in the Advanced Picture menu (page 28).
- Adjust the Phase, Tracking, or Horizontal or Vertical position in the Advanced Picture menu (page 28).
- Once you have optimized the image for a particular source, you can save the settings using Presets. This allows you to quickly recall these settings later (page 27).

## Presentation features

Several features are provided to make giving presentations easier. Here is an overview, details are found in the menu section.

- The Custom key allows you to assign various features to the button. The default effect is Source Info, which displays information about the projector and current source. See page 29 for details.
- The Search Screen option lets you change the appearance of the blank screen and start up screen (page 30).
- Two options, Auto Off and Screen Save Time, are provided to automatically shut down the projector after several minutes of inactivity or display a black screen. This helps preserve lamp life (page 29).

## Optimizing video images

After your video device is connected properly and the image is on the screen, you can optimize the image using the onscreen menus. For general information on using the menus, see page 26.

- Adjust the Keystone, Contrast, Brightness, Color, Tint or Sharpness in the Basic Picture menu (page 27).
- Change the Aspect Ratio. Choose the option that best fits your input source (page 27).
- Adjust the Color Temperature. Select a listed warmth value (page 28).
- Turn on Overscan to remove noise on the edges of the image (page 28).

## Customizing the projector

You can customize the projector for your specific setup and needs. See page 29 to page 30 for details on these features.

- For rear projection, turn Rear Project on in the **Setup** menu.
- For ceiling mounted projection, turn Ceiling Mount on in the **Setup** menu.
- Specify which source the projector checks first for active video during power-up.
- Specify the function of the Custom key on the remote.
- Turn the projector's display messages on and off.
- Turn on power saving features.
- Specify appearance of blank screen and startup screen.
- Specify the language viewed on the menus.

## Dynamic Messaging

Using command codes, text messages can be sent for display by the projector (and all other InFocus projectors with the Dynamic Messaging feature) over a network or serial connection. Text is shown on top of whatever else is being displayed, and can be shown in ticker tape format or in a box, with optional beep tone alert. This is a great way to display urgent alert messages to employees, and simply requires a connection to the projector's RS-232 serial control or LAN connector. Command codes for executing Dynamic Messaging are available on our website at [www.infocus.com/support](http://www.infocus.com/support).

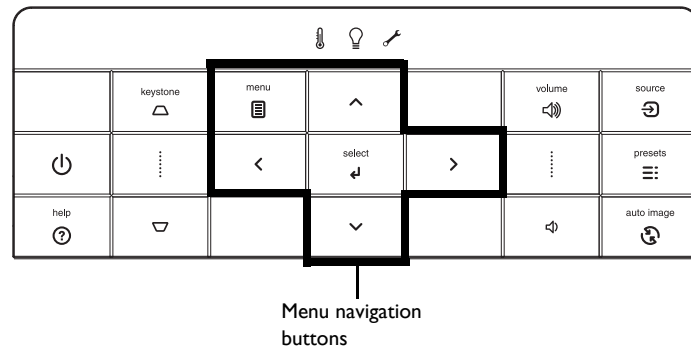
# Using the menus

To open the menus, press the **Menu** button on the keypad or remote. (The menus automatically close after 60 seconds if no buttons are pressed.) Use the arrow buttons to move up and down to highlight the desired menu, then press the **Select** button.

To change a menu setting, highlight it, press **Select**, then use the arrow buttons to adjust the value or select an option or turn the feature on or off. Press **Select** to confirm your changes. Use the arrow buttons to navigate to another setting. When your adjustments are complete, press **Menu** to access a different menu; press the **Menu** button at any time to navigate to the higher-level menu and ultimately close the menus.

The menus are grouped by usage:

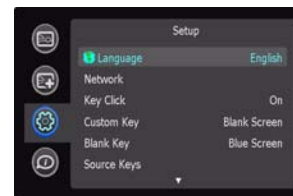
- The Basic Picture menu provides common image adjustments.
- The Advanced Picture menu provides more complex image adjustments.
- The Setup menu provides set-up type adjustments that are not changed often.
- The Status and Service menu provides information about the projector and source.



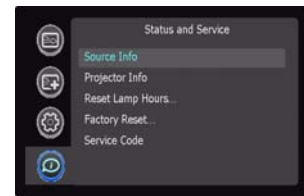
Basic Picture menu



Advanced Picture menu



Setup menu



Status and Service menu

## Basic Picture menu

To adjust the following settings, highlight the setting, press **Select**, use the arrow buttons to adjust the values, then press **Select** to confirm the changes.

**Brightness:** Changes the intensity of the image.

**Contrast:** Controls the degree of difference between the lightest and darkest parts of the picture and changes the amount of black and white in the image.

**Sharpness:** Changes the clarity of the edges of a video image. Select a sharpness setting.

**Color:** Adjusts a video image from black and white to fully saturated color. The color setting applies to video sources only.

**Tint:** Adjusts the red-green color balance in the image of NTSC video images. The tint setting applies to NTSC video sources only.

**Auto Image:** Forces the projector to reacquire and lock to the input signal. This is useful when signal quality is marginal.

**Aspect Ratio:** Aspect ratio is the ratio of the image width to image height. TV screens are usually 4:3. HDTV and most DVDs are 16:9.

Select Auto to have the projector choose the ratio. Choose Native to see the unmodified input with no resizing by the projector. Select 16:9 to watch enhanced widescreen DVDs.

For more information regarding Aspect Ratio, see page 13.

**Apply Preset...:** Presets are provided that optimize the projector for displaying computer presentations and video images under certain conditions.

There is also a user-definable preset. To set this preset, adjust the image and select Save User in the Presets menu. You can recall these settings in the future by selecting the User preset.

**Keystone:** Adjusts the image vertically and makes a squarer image.

**Digital Zoom:** Changes the size of projector's display area. If the display area has been resized by this setting, it can be moved by changing the **Horz Shift** and **Vert Shift** settings.

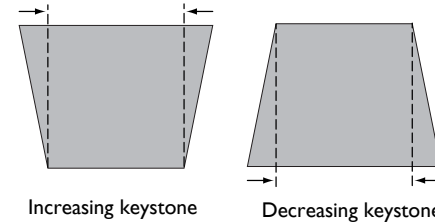
**Horz Shift/Vert Shift:** Moves the display area horizontally or vertically if its size has been changed by the **Digital Zoom** setting.



Basic Picture menu



Aspect ratio



## Advanced Picture menu

**BrilliantColor™** : Produces an expanded onscreen color spectrum that delivers enhanced color saturation for bright, true-to-life images. Choose Normal Look for most video sources and Bright Look for most computer sources.

**White Peaking:** (video sources only) Increases the brightness of whites that are near 100%.

**Color Temperature:** Changes the intensity of the colors. Select a listed relative warmth value.

**Force Wide:** When this is off, the analog locking algorithms choose the standard mode resolution (4:3) as the preferred default resolution. When this is on, the analog locking algorithms choose wide mode resolution (16:10) as the preferred default resolution.

**Overscan:** Removes noise around the video image.

**Phase:** Adjusts the horizontal phase of a computer source.

**Sync Threshold:** (progressive signals only) If a hardware device, such as a DVD player, is not syncing properly with the projector, select this option to help it to sync when connected to the projector.

**Tracking:** Adjusts the vertical scan of a computer source.

**Color Space:** This option applies to computer and component video sources. It allows you to select a color space that has been specifically tuned for the input signal. When Auto is selected, the projector automatically determines the standard. To choose a different setting, turn off Auto, then choose RGB for computer sources or choose either REC709 or REC601 for component video sources.

**Noise Reduction:** Reduces temporal and/or spatial noise in the image.

**Set Black Level...:** Analyzes the current input image and calculates an offset value which is then added to the analog to digital converter black level value. This ensures optimum black level for each analog source.

**Detect Film:** Controls film mode detection, and determines whether the original source of the input video was film or video.

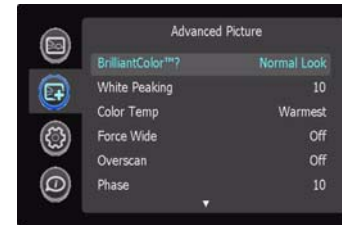
**Gamma:** Select the appropriate gamma from among Video, Film, Bright, and CRT.

**Color Gamut:** Sets the color gamut of the input signal.

**Color Gain Settings:** Adjusts the gain of the red, green, or blue channel of the image.

**Color Offset Settings:** Adjusts the offset of the red, green, or blue channel of the image.

**Horizontal/Vertical Position:** Adjusts the position of a computer source.



Advanced Picture menu

## Setup menu

**Language:** Allows you to select a language for the onscreen display.

**Network:** (IN2114 & IN2116 only) Allows you to setup network settings. See page 33 for details on network configuration and operation.

- **DHCP:** Turns the DHCP on or off.
- **IP Address:** Assign Network IP Address.
- **Subnet Mask:** Assign Network Subnet Mask.
- **Default Gateway:** Assign Network Default Gateway.
- **WINS Host Name Lookup:** Turns WINS Host Name Lookup on or off.
- **Host Name:** Shows the host name.
- **MAC Address:** Shows network MAC Address value.
- **Show Network Messages:** Turns network messages on or off. Network messages display the projector's IP address (and host name if enabled) when the projector is also displaying source messages.
- **Restart Network...:** Restarts the network.
- **Network Factory Reset...:** Performs factory reset.

**Key Click:** Turns the key click sound on or off. When this setting is on, pressing keys on the keypad causes the projector's speaker to play a "click" sound.

**Custom Key:** Allows you to assign a different function to the Custom button, allowing you to quickly and easily use the effect. Highlight an effect and press **Select** to choose a different one.

- **Source Info:** The default action. Shows the Source Info menu.
- **Projector Info:** Shows the Projector Info menu.
- **Aspect Ratio:** Sets the ratio of image width to image height (see page 13 and page 27).
- **Auto Image:** Resynchronizes the projector to the source (page 24).
- **Overscan:** Removes noise around the image.
- **Blank Screen:** Displays an empty screen.
- **Freeze Screen:** Pauses the projected image.
- **Mute:** Turns off all sound.

- **AV Mute:** Enables or disables AV Mute function.
- **Source:** Cycles through available sources.
- **Closed Captions:** Enables or disables Closed Captions.

**Blank Key:** Select what to display when the blank key on the remote is depressed: your custom snapshot, a solid color screen (blue, black or white), the factory logo screen, a timer, or test patterns. The timer option is useful for classroom tests or break times during meetings.

**Source Keys:** Enables or disables Source Keys on the optional Commander-2 remote.

**AC Power On:** When this feature is on, the projector automatically turns on when electrical power is connected. This allows control of ceiling mounted projectors with a wall power switch.

**Auto Off Time:** Automatically turns the projector off after no signals are detected for a preset number of minutes. If an active signal is received before the projector powers down, the image will be displayed.

**Screen Save Time:** Automatically blanks the screen with a black color after no signals are detected for a preset number of minutes. The image returns when an active source is detected or a remote or keypad button is pressed.

**Sleep Timer:** Allows the projector to automatically power off after it has been on for a specified amount of time.

**Always-On Functions:** Allows you to control which projector functions will work even when the projector is in standby (powered off but connected to AC Power). Press Up or Down to highlight the function you want to change, then press select or left and right to change the function to either Yes or No. Press menu when done. Note that some functions must always have the same value; in this case when you change one value, other values in the submenu may also change automatically.

**Lamp Low Power:** Toggles between on and off. Turn it on to lower the light output of the lamp. This also lowers the fan speed, making the projector quieter.

**Power Sounds:** Controls whether the projector makes a sound when powered on and off.

**Internal Speakers:** Allows the user to turn on and off the internal speakers.

**Audio Inputs:** Assign an audio input to a specific video/computer source input. (Default settings are as follows: Audio 1 is used with VGA 1 and VGA 2; Audio 2 is used with S-video and composite.)

Press up or down to highlight the source you want to change, then press select or the left and right arrow keys to change that source's audio input. Press menu when done changing audio inputs.

**Auto Source:** When this feature is On, the projector automatically finds the active source, checking the selected Power-up Source first. When this feature is Off, the projector defaults to the source selected in Power-up Source. To display another source, you must manually select one by pressing the **Source** button on the remote or keypad.

**Fast Color Refresh:** Controls color wheel speed.

**Power-up Source:** Determines which source the projector checks first for active video during power-up.

**VGA 1 SCART:** If a SCART source is connected to VGA 1 (using an adapter), use this feature to select the SCART type.

**VGA 2 SCART:** If a SCART source is connected to VGA 2 (using an adapter), use this feature to select the SCART type.

**Video Standard:** When this feature is set to Auto, the projector attempts to automatically pick the video standard based on the input signal it receives. (The video standard options may vary depending on your region of the world.) If the projector is unable to detect the correct standard, the colors may not look right or the image may appear "torn." If this happens, manually select a video standard by selecting NTSC, PAL, or SECAM from the Video Standard menu.

**Closed Captions:** Controls closed caption display while audio is not muted. If this setting is not off, and audio is not muted, and the source is NTSC and contains captions on the selected channel, then the projector must display caption text overlaid on the image.

**Ceiling Mount:** Turns the image upside down for ceiling-mounted projection.

**Rear Project:** Reverses the image so you can project from behind a translucent screen.

**Auto Keystone:** Enables and disables the projector's automatic vertical keystone adjustment.

**Prevent PC Screen Saver:** Prevents your computer from going into Screen Save mode. The projector must be connected to the PC via a USB cable for this feature to work.

**Search Screen:** Allows you to display a blank screen instead of the default screen at startup, and when no source is detected.

**Take Snapshot...:** Captures the current image and allows it to be used as the search screen image.

**Disable Snapshot:** Allows the user to disable the snapshot capability.

**Show Messages:** Displays status messages (such as "Searching") in the lower-left corner of the screen.

**Menu Offset:** Allows you to change the position of the On Screen Display items.

**Menu Transparency:** Allows you to change how much of the projected image behind the menu you can see. As the value increases, more of the image behind the menu is visible.

**Magnify Controls:** Allows you to change the function of the arrow buttons when the menu is not shown. By default, the arrow buttons allow you to advance slides while in PowerPoint's SlideShow mode. To make the arrow buttons also adjust magnify settings, choose Magnify Controls to turn magnify controls on. Now when the menu is not shown, you can press the Select button to switch between the magnification settings (Magnify Level, Magnify Horizontal Position and Magnify Vertical Position), then press Select again to turn off magnify controls and use the arrow buttons to advance slides.

**Keypad Enable:** Enables or disables keypad.

**Glow Ring:** Controls the brightness level of the glow ring status indicator.

**PIN Protect:** The PIN (personal identification number) feature allows you to password protect your projector. Once you enable the PIN feature, you must enter the PIN before you can project an image. The default PIN on this projector is **Menu-Up-Down-Select-Source**. Use the navigation buttons on the remote or keypad to enter the correct 5-button press sequence. When all 5 numbers are entered correctly, press the **Select** button on the remote or keypad to select OK. If the message “Wrong PIN” appears, verify the code and re-enter it. If you mis-enter a number, you must enter 5 numbers and press the **Select** button in order to access the “Wrong PIN” message and re-enter the code.

#### **To enter the PIN at projector startup:**

Power up the projector. The “Enter PIN” dialog box appears after the startup screen. Enter the PIN. Use the navigation buttons on the remote or keypad to enter the correct button press sequence. See the description above for instructions.

#### **To change the PIN:**

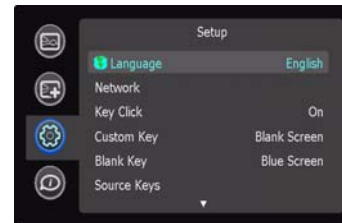
Select “Change PIN...” in the Setup menu. Enter the existing PIN. Enter the new PIN. You can navigate between OK and Cancel by pressing the arrow buttons on the keypad. Select OK or Cancel by pressing the **Select** button. Verify the new PIN.

#### **If you lose or forget your custom PIN:**

Contact InFocus support at [www.infocus.com/support](http://www.infocus.com/support).

**Serial Port, Baud Rate:** Selects the serial port and baud rate.

**Serial Port Echo:** Controls whether the serial port echoes characters.



Setup menu



## Status and Service menu

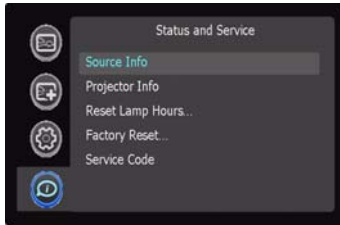
**Source Info:** Displays current source settings (read-only).

**Projector Info:** Displays current projector settings (read-only).

**Reset Lamp Hours:** Resets the lamp hours used counter in the Projector Info menu to zero. Do this only after changing the lamp.

**Factory Reset:** Restores all settings to their default.

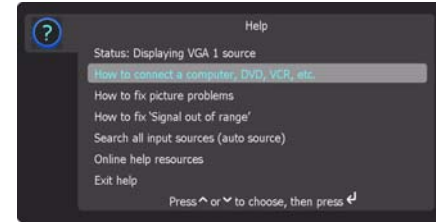
**Service Code:** Only used by authorized service personnel.



Status and Service menu

## Help

Press **Help** (on the keypad or remote) at any time to get interactive help for solving common, picture, sound, and cabling problems.



**NOTE:** The projector can be re-programmed to display a custom (non-interactive) screen when Help is pressed. To do this: Create your custom screen on a computer and display it on the projector, then use the Take Snapshot command in the Setup menu. When you see the Snapshot Successful message, hold down the Help button until the message is removed.

To revert a customized Help screen back to the InFocus default Help screen, a Factory Reset will be needed.

# Using Network Functions (IN21 I4 & IN21 I6 only)

**IMPORTANT:** To enable network functions at all times (even when the projector is powered off), the Network item in the Always-On Functions submenu in the Setup menu must be set to Yes (not No).

Projector network functions include:

- Configuring and controlling the projector via a web browser.
- Failure and warning alerts via email.
- Projector Management via SNMP.
- Controlling the projector via Scheduling.

**NOTE:** Projector web pages and emails sent by the projector are always displayed in English language.

## Before using the network functions

To use the network functions of the projector, the projector must be configured to suit your network. Consult with your network administrator before connecting the projector to your network; incorrect network configuration of the projector may cause problems on your network.

## Connect the Network Cable

Properly connect projector to the network, then configure the following settings.

### If Using a Network with DHCP Enabled:

- 1 Use the projector's remote control or keypad to select the Network item in the projector's Setup menu.
- 2 If DHCP is off, select it to turn it on.

### If Using a Network that Does Not have DHCP Enabled:

- 1 Use the projector's remote control or keypad to select the Network item in the projector's Setup menu.
- 2 If DHCP is on, select it to turn it off.

**NOTE:** If you still don't see an IP address, go to the projector's Setup menu, select Network, then turn on Show Network Messages. After exiting the menu press the Source button again.

- 3 Select IP Address. This will highlight the first of the four octets in the IP address. Press **Up** or **Down** to change the value, then press **Select** or **Right** when done to move to the next octet. Repeat until you have changed all four octets in the IP address.
- 4 Repeat the above for Subnet Mask, Default Gateway, and other settings that are in IP address format (to assign or change the Host Name, see **Network Settings Page** below).

## Configuring and Controlling the Projector via a Web Browser

You can adjust or control the projector via a network from a web browser on a computer that is connected to the same network as the projector.

### NOTES:

- To access the projector's web pages, the projector must be connected to the network and connected to AC power (and if you want to access the web pages even when the projector is powered off, make sure that the Network item in the Always-On Functions submenu is set to Yes).
- JavaScript must be enabled in your browser to use the projector web pages properly. If JavaScript is disabled, see the Help files for your web browser for details on how to enable it.
- If no operations are performed in the web browser for approximately ten minutes, the system will automatically log you off.

## Logging in

To log into the projector web pages, follow these steps:

- 1 Make sure the projector is connected to the network and connected to AC power.
- 2 If you don't know the projector's IP address, turn on the projector. After the projector starts up, if its IP address is not shown, press the **Source** button to view the IP address.

IP Address: 192.168.1.10

- 3 Start a web browser on your computer.
- 4 Enter the projector's IP address or host name (preceded by http://) into the web browser's address bar. Example: If the IP address is 192.168.1.10, enter http://192.168.1.10 into the browser's address bar.
- 5 The Log In to Projector Control page will be shown in the browser.
- 6 Select Access type: **Basic User** or **Administrator**.
- 7 Click **Log In**.

### Navigating Projector Web Pages

The left side of every page shows a navigation bar. Click the links in the navigation bar to go to different projector web pages.

**NOTE:** If a Basic User is logged in, no links are shown.

The top of the navigation bar shows the projector name, model, and serial number.

The web pages also include the following options:

- **Log Off:** Logs off and returns to the Log In page (see above).
- **Refresh:** Reloads the page with current status.
- **Defaults:** Displays default (factory settings) values (to save these values click Apply).
- **Apply:** Saves the values that are currently shown on the page.

### Projector Controls Page (All users)

This page lets you control the same settings that are available via the projector's main menu and remote control. The Controls tab includes basic remote control functions; other tabs correspond to the projector's menus. **NOTE:** If a Basic User is logged in, only the Controls, Basic Picture, and Advanced Picture tabs are shown.

In each tab, the current value of each setting is shown in blue color.

**NOTE:** Unlike other pages, changes you make to Projector Control settings are applied immediately.

- **To change an on/off setting** (e.g. Power): Click the corresponding **On** or **Off** button.
- **To change a multi-value setting** (e.g. Sharpness): Select a value from the drop-down menu.
- **To change a numeric setting** (e.g. Brightness): Click the corresponding + or - button, or select a value from the drop-down menu.
- **To perform a command** (e.g. Auto Image): Click the corresponding Execute button.

### Network Settings Page (administrators only)

This page lets you view and change the projector's network settings. Consult with your network administrator before making any changes on this page; incorrect network configuration of the projector may cause problems on your network.

**Projector Name:** The name of the projector shown in the projector's web pages.

**IP Address:** These settings control the projector's network configuration. Enter the appropriate settings required for your specific network.

**Advanced Network Settings:** Click this link to show advanced settings:

**802.1x Authentication:** If your network requires 802.1x authentication, enter the user name and password that the projector should use, and select the authentication type.

**SNMP:** If your network uses SNMP, enter necessary SNMP information here.

**Command and Control Pass-Through:** This setting allows you to send and receive projector commands over the network. For command codes, visit the InFocus website at: [www.infocus.com/support](http://www.infocus.com/support).

### Event Notifications Page (administrators only)

This page lets you configure the projector to automatically send email when specific events occur.

**E-Mail Settings tab:** In the Account Used... section, enter the information needed for your projector to connect to an email sending (SMTP) server. Then in the Recipient E-Mail Addresses section, enter the email addresses of people who will receive emails, and for each address, select whether that address receives reminders and/or warnings and errors (enter only one address per line). After you have completed this page, click Send Test to make sure that email is correctly set up.

**Reminders tab:** Select which types of reminders to send. For most reminders, you can adjust the frequency or date/duration associated with the reminder.

**Warnings & Errors tab:** Select which warnings and errors to send.

### Date/Time Settings Page (administrators only)

This page lets you configure the projector to read the time and date from an SNTP server on your network. NOTE: The projector does not have a built-in clock. If the projector is unable to access the SNTP server, or no SNTP server is defined, functions that rely on the time and date may not work correctly.

**Current Date and Time:** Shows the current date and time read from the SNTP server.

**Synchronize the system clock...:** Select how often the projector should check the SNTP server to get the time and date. Between checks, the projector will keep track of the amount of time elapsed, allowing it to maintain the correct time and date.

**SNTP Server:** The address of the time and date server on your network.

**Time Zone:** The projector's time zone (if you are in a different time zone from the projector, make sure this is the time zone of the region where the projector is located).

**Set Now:** Click this to immediately set the time and date based on the above information.

**Daylight Savings Settings:** Click this link to show daylight savings settings:

**Start:** Select when daylight savings starts.

**End:** Select when daylight savings ends.

**Automatically adjust...:** Check this to have the projector automatically update time and date when daylight savings starts and ends.

### Scheduled Tasks Page (administrators only)

This page lets you configure the projector to perform tasks automatically on specific days and times. You can set up a maximum of three different scheduled tasks; each tab corresponds to a task. Each scheduled task can perform different commands on different days and times. Each tab contains the following items:

**On/Off:** Select whether or not this scheduled task will run on the days and times shown.

**Description:** Explanation of what the task does.

**Run Every:** Select the days of the week when the scheduled task should run.

**At Time(s):** Select the times of day when the scheduled task should run (the task will run at the indicated times on every one of the days checked above).

**Command Sequence and Available Commands:** The Command Sequence list on the left shows commands currently performed by the scheduled task (each task can include up to 20 commands). The Available Commands list on the right shows all commands that can be added to a scheduled task.

**<< Add:** Adds the command selected in the Available Commands list to the Command Sequence list.

**>> Remove:** Removes the command selected in the Command Sequence list.

**Move Up:** Moves up the command selected in the Command Sequence list.

**Move Down:** Moves down the command selected in the Command Sequence box list.

**Clear All:** Erases all commands in the Command Sequence list.

**Custom:** Click this link to show custom command entry options. With custom commands, you can perform additional commands not shown in the Available Commands list. The RS-232 command codes are available on our website at [www.infocus.com/support](http://www.infocus.com/support). NOTE: Custom commands you enter here should be in write format (do not include '?'), and should use '<' and '>' instead of '(' and ')'. Example: to turn on the ceiling mount setting, use the custom command <CEL1>.

### Security Settings Page (administrators only)

This page lets you configure security options for the projector, including log in passwords and projector access restrictions.

**Web Access - Administrator tab:** Select whether or not Administrators must enter a password to log into the projector's web pages. If a password is required, click create or change password to update the administrator password.

**Web Access - Basic User tab:** Select whether or not Basic Users must enter a password to log into the projector's web pages. If a password is required, click create or change password to update the basic user password.

**Projector PIN tab:** Allows you to turn projector PIN protection on or off, or change the PIN. When PIN protection is on, the current PIN must be entered when the projector is powered on, otherwise the projector will not operate. NOTE: PIN protection only applies to projector operation via the projector's keypad and remote control; it does not affect the projector's web pages.

### System Log Page (administrators only)

This page shows a log of the 100 most recent projector events.

**Erase Log...:** Click this to erase all events in the log.

### Network Utilities Page (administrators only)

This page lets you perform various network-related projector tasks.

**Save and Load Projector Configuration:** These functions save and load all network-related projector settings into/from a file stored on your computer. This lets you quickly 'clone' network settings from one projector to other projectors.

**Upgrade Projector Network Firmware:** Upgrades the firmware for the projector's network and LitePort features (this firmware is separate from the regular projector firmware).

**Restart Projector Network Subsystem:** Restarts the projector network subsystem; does not change any projector settings.

**Network Subsystem Factory Reset:** Returns all network and LitePort settings to default values and then restarts the projector network subsystem.

### Troubleshooting Network Functions

- If network status is shown as **Not Connected** in the projector's Network menu, or the projector does not display its IP address, check the cable or the network configuration.
- If your web browser displays **Page Not Found** or a similar error when you try to access the projector's web pages, verify that the projector is connected to the network (select the Network item in the projector's Setup menu and verify that Network Status shows as Connected); if there is no connection refer to the troubleshooting item above for more help.
- Make sure the Network item in the Always-On Functions submenu in the Setup menu is set to Yes (if it is set to No, the projector web pages will only be available when the projector is powered on).
- If scheduled tasks are not performed, check if the SNTP is set up correctly and is online. Also check if the Command sequence is correct.
- If automatic emails are not sent, check if SMTP is set up correctly and is online.

**To manually restart the projector network subsystem:** Use the projector's remote control or keypad to select the Network item in the projector's Setup menu. Then scroll down and select either Restart Network (to restart the network subsystem without changing any settings), or Network Factory Reset (to return all network settings back to default values, and then restart the network subsystem). **If the manual restart procedure does not work:** To force the network subsystem to restart, disconnect the projector from AC power, wait 10 seconds, then reconnect AC power.

## Using LitePort (IN2114 & IN2116 only)

LitePort displays a slide show of JPEG images stored on a USB flash drive connected to the projector. This feature eliminates the need for a computer source and can be integrated with common wall plates and conference room input/output panels.

### Image File Types

LitePort displays image files in JPEG format only (file extensions .JPEG and .JPG). Other file types including PDF, BMP, TIFF, PNG, GIF, etc. are ignored.

### Viewing a Slide Show

To view your pictures as a slide show, follow these steps:

- 1 Connect a USB flash drive to your computer and copy JPEG files from your computer to the USB flash drive.
- 2 Turn on your projector if needed.
- 3 Remove the USB flash drive from your computer and plug it into the LitePort connector on the rear of the projector.
- 4 The projector will start a slide show of the images found (if you see image thumbnails instead, see To Start the Slide Show section below).
- 5 To go to the next image in the slide show, press the Down or Right arrow button on the projector keypad or remote. To go to the previous image, press the Up or Left arrow button.

### Controlling LitePort

When you plug a USB flash drive into the projector's LitePort connector, the projector will scan the drive and then either start a slide show or show image thumbnails.

**To stop the slide show and view thumbnails:** Press the **Select** button during the slide show. In Thumbnails view, the name of the current folder, the current image number, and the total number of images in that folder are shown at the bottom of the screen. While viewing thumbnails, press the arrow but-

tons to scroll through the thumbnails, or press **Select** when an image is highlighted to start the slide show, or press **Select** when a folder is highlighted to open that folder.

**To start the slide show:** While viewing thumbnails, press the arrow buttons to highlight a thumbnail, then press the **Select** button to start the slide show at the highlighted image.

**To change the image during the slide show:** Press the Down or Right button to go to the next image, or press the Up or Left arrow button to go to the previous image (the slide show may also advance automatically depending on the value of the Next Slide setting; see the LitePort Menu section below for details).

**To change to a different folder:** While viewing thumbnails, press the arrow buttons to highlight the desired folder icon, then press the **Select** button (to go to the higher-level folder, select the folder icon labeled "Up").

**To change LitePort settings:** Press the **Menu** button during the slide show, or while viewing thumbnails (see the LitePort Menu section below for details).

### Using the LitePort Menu

To show the LitePort menu, press the **Menu** button on the keypad or remote during the slide show, or while viewing thumbnails. To highlight a menu item, press arrow buttons. Then to do the action or change the setting, press **Select**. To remove the menu, press the **Menu** button again.

**Rotate Picture:** Rotates the current image by 90 degrees clockwise (rotation is temporary; the image returns to its original orientation when the USB flash drive is removed from the projector or when the projector is turned off).

**Stop/Start Slideshow:** Stops the slide show, or starts it at the selected thumbnail (when the menu is not visible, you can also stop or start the slide show by pressing the **Select** button).

**Go to Projector Main Menu:** Removes the LitePort menu and displays the projector's main menu, where you can adjust the picture or change other projector settings.

(For remaining items below, highlight the setting, then press Select one or more times to change the setting value.)

**Auto Start:** Select On to have the player start the slide show when the USB flash drive is first connected. Select Off to have the player display thumbnails when the USB flash drive is first connected.

**Show All Folders:** Select On to have the slide show display all images in all folders. Select Off to have the slide show display images only from the current folder.

**Fill Screen:** Select On to have the slide show expand small images to fill the screen. Select Off to have the slide show display small images at their original size.

**Next Slide:** Select Manual to disable automatic slide advance in the slide show. Select other values to make the slide show advance to the next image automatically (regardless of this setting, manual advance is always available by pressing the arrow buttons).

**Effect:** Select Off to have no transition effect when changing between images during the slideshow. Select Random to use a different random effect for each transition. Select other values to use a specific effect.

**Show Info:** Select On to show the name of the current file and folder, the current image number, and the total number of images in the slide show at the bottom of the screen. Select Off to hide this information.

### Displaying PowerPoint Slides

Follow the steps below to display PowerPoint slides using LitePort (these instructions apply to PowerPoint 2007 in Windows; for other presentation programs refer to the program's instructions or help file for the steps needed to save a presentation as separate JPEG files):

- 1 Connect the USB flash drive to your computer.
- 2 Open your PowerPoint document.
- 3 This step is optional but improves image quality: Click the **Design** tab near the top of the PowerPoint document window, then click **Page Setup**.

Click the **Slides sized for** drop-down menu and select Custom. Change both Width and Height to double their previous values, then click **OK**.

- 4 Click the Office button in the upper left corner of the PowerPoint document window.
- 5 Point to **Save As**, then click **Other Formats**.
- 6 In the Save As dialog box, click the **Save as type** drop-down menu. Scroll through the menu and select JPEG File Interchange Format.
- 7 Make sure the contents of your USB flash drive are visible in the Save As dialog box before you continue - to view your USB flash drive in the Save As dialog box, first click My Computer, then double-click the USB flash drive's icon (make sure you do both of these in the Save As dialog box, not on your computer's desktop).
- 8 Click **Save**. PowerPoint will ask if you want to export every slide or only the current slide; click **Every Slide**. PowerPoint will save each slide in your presentation as a separate JPEG file. These files are saved in a new folder that has the same name as the original document.
- 9 Remove the USB flash drive from your computer and plug it into the projector's **LitePort** connector.
- 10 On the projector, navigate to the folder created in step 8 and then start the slide show (for instructions on navigating and controlling the slide show, see the Controlling LitePort section above).

**NOTE:** PowerPoint embedded videos, transition effects, and animations are not included when saving as JPEG. However, you can select a LitePort slideshow transition effect by changing the Effect in the LitePort menu.

## Troubleshooting LitePort

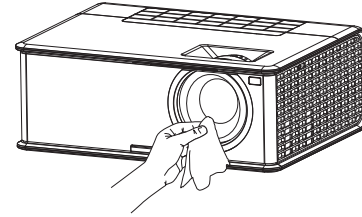
- If images load slowly: Make sure you are using a newer USB 2.0-compatible (high speed) USB flash drive. Larger image file sizes may also slow down the player; to reduce file size, use an image editing program on your computer to resize images smaller; for the best balance between image quality and speed, resize images to be 1024 pixels wide.
- If no images are found, or some images are not shown, or you only see folder thumbnails but no images: Make sure that images are JPEG file type (file extensions .JPEG and .JPG); other file types are not supported and will be ignored.
- If you see a blank screen, or a logo, or the wrong input source (computer, video, etc.) instead of your images: Keep pressing the Source button on the keypad or remote until the LitePort message is displayed (if you still don't see any images, make sure the USB flash drive is correctly and completely plugged into the projector's LitePort connector).
- If nothing happens when you connect your USB flash drive, and you cannot select the LitePort input source as described above: Check the format of your USB storage device. LitePort only supports USB storage devices formatted as FAT32. Devices formatted as NTFS, and non-storage devices (such as cameras) are not supported.
- If images saved by PowerPoint are low quality: Make sure to do step 3 when following the steps in the Displaying PowerPoint Slides section above.



# Maintenance

## Cleaning the lens

- 1 Turn the projector off and unplug the power cord.
- 2 Slide open the lens cover, if the lens is covered.
- 3 Apply a non-abrasive camera lens cleaner to a soft, dry cloth.
  - Avoid using an excessive amount of cleaner, and don't apply the cleaner directly to the lens. Abrasive cleaners, solvents or other harsh chemicals might scratch the lens.
- 4 Lightly wipe the cleaning cloth over the lens in a circular motion.



### WARNINGS:

- Turn the projector off and unplug power cord before cleaning any part of the projector.
- Do not open any cover on the projector, except the lamp cover.
- Do not attempt to service this product yourself as opening and removing covers may expose you to dangerous voltage and other hazards. Refer all servicing to qualified service personnel.

## Replacing the projection lamp

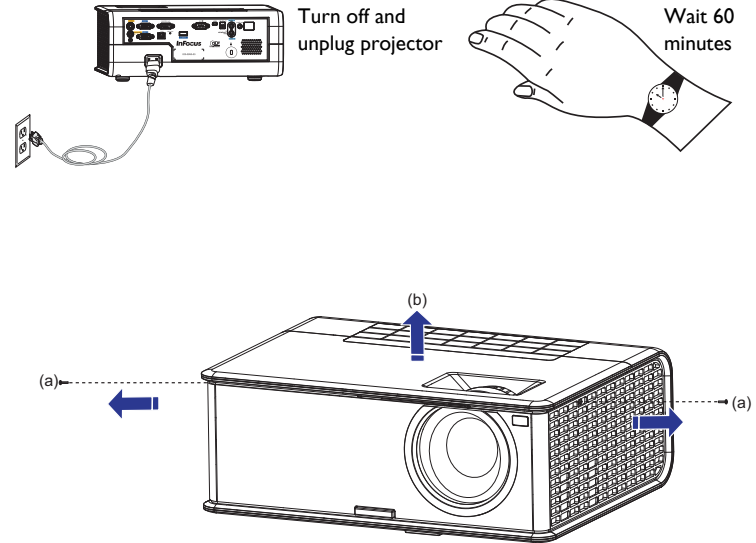
The lamp hours timer in the Projector Info menu counts the number of hours the lamp has been in use. Twenty hours before the lamp life expires, the message “Replace lamp” appears on the screen at startup.

- **NOTE:** Be sure to use the InFocus lamp module designed for this projector. You can order new lamps from [www.infocus.com](http://www.infocus.com) (in select areas), your retailer or your dealer. **Only genuine InFocus lamps are tested for use in this projector.** Use of non InFocus lamps may cause electrical shock and fire, and may void the projector warranty. InFocus is not liable for the performance, safety or certification of any other lamps.

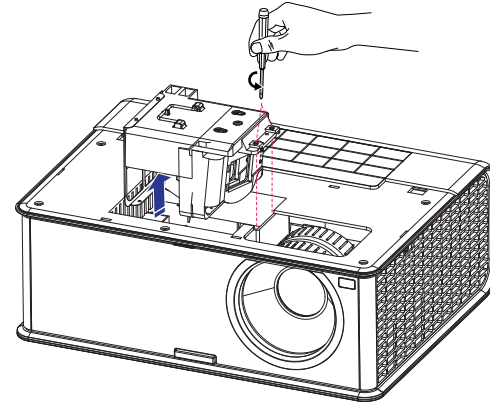
### WARNINGS:

- The projector uses a high-pressure mercury glass lamp. The lamp may fail prematurely, or it may rupture with a popping sound if jolted, scratched, or handled while hot. The risk of lamp failure or rupture also increases as the lamp age increases; please replace the lamp when you see the “Replace Lamp” message.
- To avoid burns, allow the projector to cool for at least 60 minutes before you replace the lamp.
- Unplug the power cord before replacing the lamp.
- Do not drop the lamp module. The glass may shatter and cause injury.
- Do not touch the glass surface of the lamp module. Fingerprints can obscure projection sharpness and may cause the glass to shatter.
- Be extremely careful when removing the lamp housing. In the unlikely event that the lamp ruptures, small glass fragments may be generated. The lamp module is designed to contain most of these fragments, but use caution when removing it.
- Before replacing a ruptured lamp, clean the lamp compartment and dispose of cleaning materials. Wash hands after lamp replacement.
- When replacing the lamp while the projector is ceiling-mounted, wear protective eyewear to prevent eye injury.
- Hg – Lamp contains mercury. Manage in accordance with local disposal laws. See [www.lamprecycle.org](http://www.lamprecycle.org).

- 1 Turn off the projector and unplug the power cord.
- 2 Wait 60 minutes to allow the projector to cool thoroughly.
- 3 Remove the top front cover by (a) removing the screws on the two sides of the projector, and (b) lifting the top front cover off.

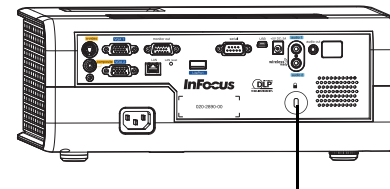
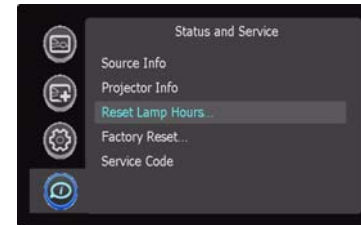


- 4 Loosen the two captive screws that attach the lamp housing to the projector.
- 5 Using the handle, carefully remove the lamp housing. Dispose of the lamp in an environmentally proper manner in accordance with local disposal laws.
- 6 Install the new lamp housing, pressing the lamp into place.
- 7 Tighten the captive screws.
- 8 Replace the top front cover and tighten both screws.
- 9 Plug in the power cord and press the **Power** button to turn the projector back on.
- 10 To reset the lamp hour timer, navigate to the **Status and Service** menu and select **Reset Lamp Hours**. See page 32 for details.



## Using the security lock

The projector has a security lock for use with a Cable Lock System. Refer to the information that came with the lock for instructions on how to use it.



Security Lock

# INDEX

## Numerics

16x9 vs 4x3 12

## A

Aspect Ratio 12, 13

Audio In Computer connector 9

Audio Out connector 23

## C

cable box 12

Computer In connector 8

Connecting

external speakers 23

connecting

computer 8

video device 12

Connecting a computer source 8

contacting InFocus 21

customer service contact information 21

## D

Digital Zoom 27

Displaying an image 9

Dynamic Messaging 25

## F

focus 11

## H

Help 32

## K

keypad buttons 24

Keystone 18

## L

laptop video port activation 10

LitePort

Using LitePort 37

## M

menu usage 26

Monitor Out connector 9

## N

Network

Using Network Functions 33

## O

Optimizing computer image 24

Optimizing video images 25

## P

Position the projector 6

Power connector 8

power cord 8

Presentation features 24

Projector

keypad buttons 24

menus 26

projector

connecting computers 8

connecting video devices 12

positioning 6

setting up 6

shutting down 14

troubleshooting problems 14

## R

remote control 22

## S

Scheduled Tasks Page 35

Screen Aspect 12

Screen Save 14

shutting down the projector 14

speakers, connecting external 23

S-video connector 12

## T

Troubleshooting Network Functions 36

TV tuner 12

## U

USB 8

**V**

Viewing a Slide Show 37

Volume button 23

**W**

warranty 21

**Z**

zoom 11